

Spherical roller bearings, cylindrical and tapered bore

Principal dimensions			Basic load ratings		Speed ratings		Designation
d	D	B	dynamic C	static C0	Reference speed	Limiting speed	
mm			kN		r/min		* SKF Explorer bearing
130	230	80	826	1060	1900	2600	23226 CCK/W33 *

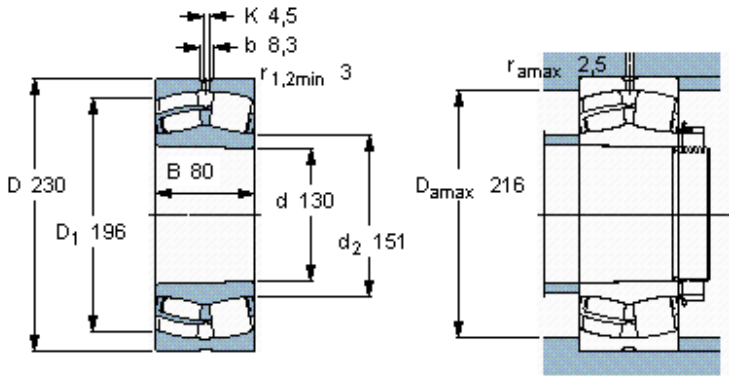

Tapered bore, taper
1: 12

Calculation factors

- e 0,33
- Y₁ 2
- Y₂ 3
- Y₀ 2